

G-8179H-2L2C-T

Finezza Due Series

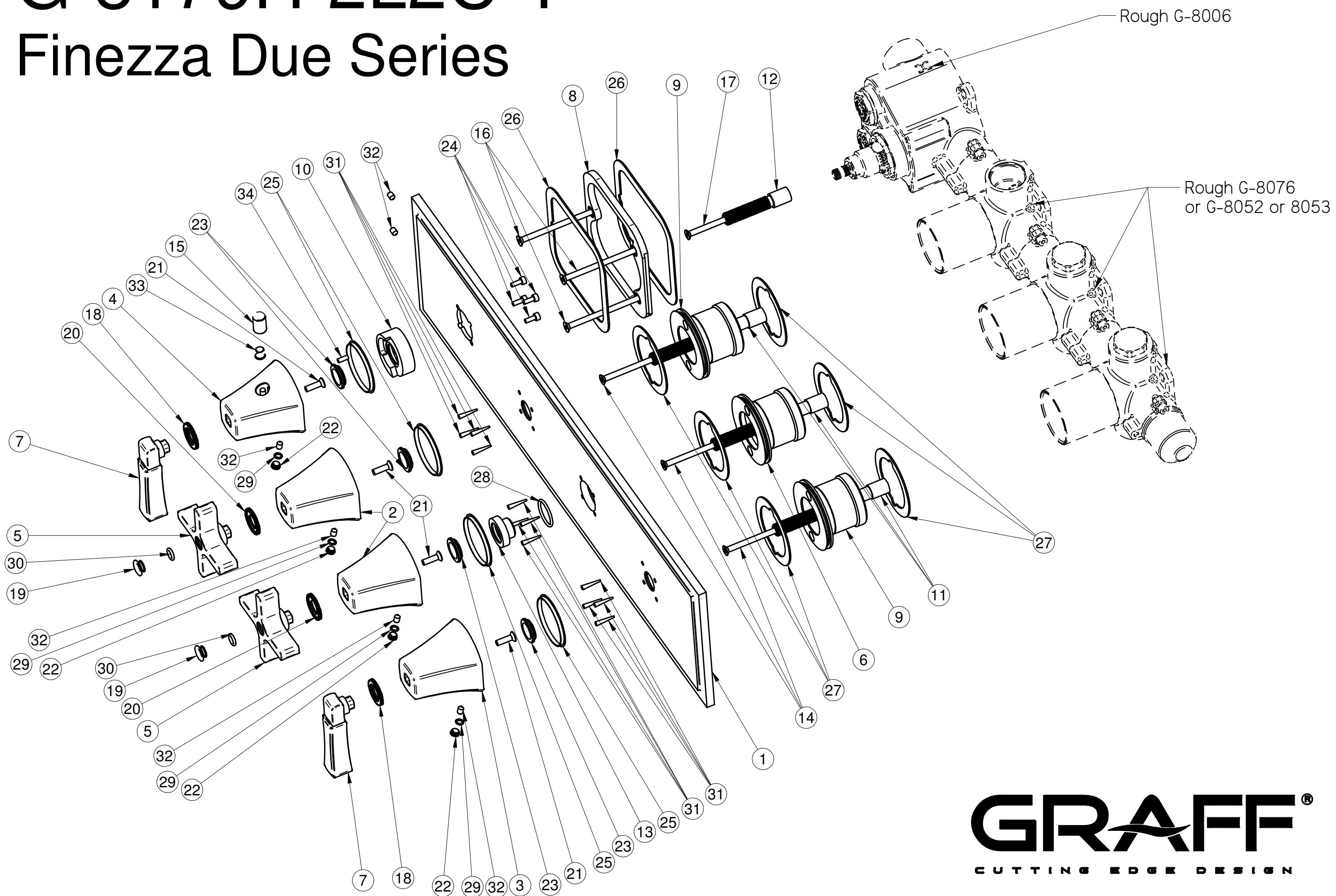

GRAFF[®]
CUTTING EDGE DESIGN